



DUCT-O-BAR

HD Series Conductor Systems

500, 1000 & 1500 Ampere Sizes

A high amperage system of heavy duty conductor bars for large cranes and mobile equipment where strength, reliability and safety are required.

- Lightweight aluminum conductor with stainless steel contact surface
- High strength bolted joints
- Inverted "V" contact surface to ensure positive collector tracking
- Full support hanger clamps
- Low maintenance — long life

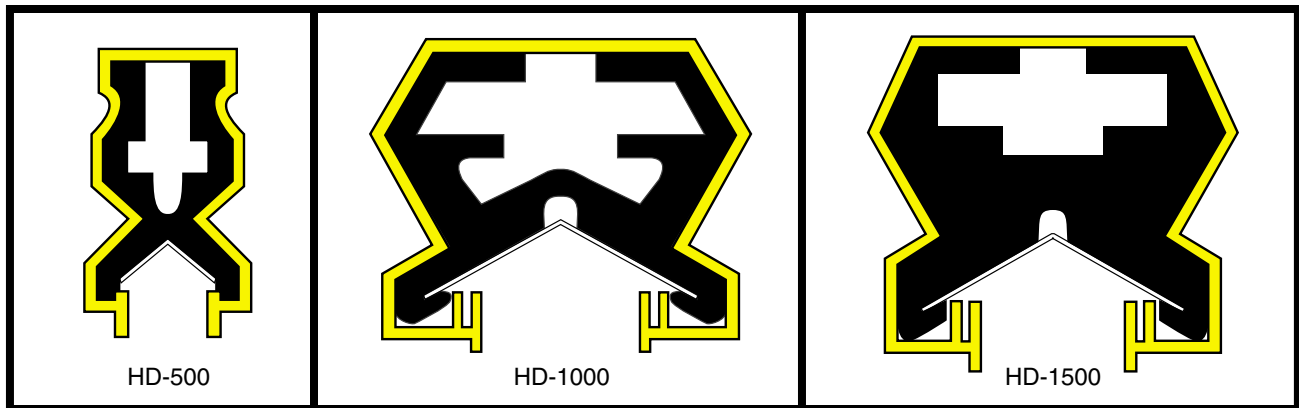

CAUTION

MAKE CERTAIN POWER SUPPLY IS DISCONNECTED BEFORE INSTALLING, REPAIRING, OR WORKING IN THE PROXIMITY OF ANY ELECTRICAL SYSTEM. ONLY QUALIFIED ELECTRICAL PERSONNEL SHOULD INSTALL OR REPAIR THESE PRODUCTS.

www.duct-o-wire.com

P.O. Box 519

Corona, California 91718-0519

Phone: 909-735-8220; 800-543-3885; 800-735-1922

Fax: 909-735-2372; 800-752-6001; 800-735-0857

1351 W. Second Street

Oconomowoc, Wisconsin 53066

Phone: 262-567-2288

Fax: 262-567-0857

379 Davis Road, Unit #3

Oakville, Ontario, Canada L6J 2X2

Phone: 905-844-1791; 800-361-9473

Fax: 905-844-2533; 800-663-0933



Conductor Bar Selection

Determining Ampere Load

The conductor selected must be large enough to carry the necessary ampere load safely without undue heating. To compute the ampere load, proceed as follows:

1. List the horsepower of all motors used in the application.
2. Determine the voltage and type of current that will feed the conductor. For example: 230v dc 2 wire; 460v ac 3 phase; etc.
3. Refer to the Horsepower Conversion Table and convert the horsepower to amperes.
4. Prepare the ampere load figure that will be used to size the conductors as follows:

List the full load ampere rating of each motor used on the crane or monorail unit. Determine the duty cycle from the following paragraphs and apply the corresponding factor.

Average Duty — Class C Crane Service

Moderate use during the work day. Five to ten lifts per hour. Not over 50% of the lift at rated capacity. Use a factor of 100% of the calculated ampere load.

Heavy Duty — Class D Crane Service

Used continually during the work day and usually for more than one shift. Loads of 50% of rated capacity or more handled constantly during the work period. Use a factor of 110% of the calculated ampere load.

Severe Duty — Class E and F Crane Service

Handles loads approaching 100% of the capacity all during the work period and for more than one shift. This includes large, heavy duty units such as bucket cranes, magnet lift cranes, cement or steel handling cranes. Use a factor of 120% of the calculated ampere load.

Horsepower Conversion Table

3 Phase AC — 60 Cycle Amperes				Direct Current Amperes
H.P.	230v	460v	575v	230v
1/2	2	1	.8	2.7
3/4	2.8	1.4	1.1	3.8
1	3.6	1.8	1.4	4.7
1-1/2	5.2	2.6	2.1	6.6
2	6.8	3.4	2.7	8.5
3	9.6	4.8	3.9	12.2
5	15.2	7.6	6.1	20
7-1/2	22	11	9	29
10	28	14	11	38
15	42	21	17	55
20	54	27	22	72
25	68	34	27	89
30	80	40	32	106
40	104	52	41	140
50	130	65	52	173
60	154	77	62	206
75	192	96	77	255
100	248	124	99	341
125	312	156	125	425
150	360	180	144	506
200	480	240	192	675

Induction Type Squirrel Cage and Wound Rotor Motors

The Horsepower Conversion Table is taken from the 1996 NEC Article 430. The values are for motors running at usual speeds with normal torque characteristics. Motors built for especially low speeds or high torques may require more running current, and multi-speed motors will have full-load current varying with speed. In these cases, use the higher current rating from the nameplate.

The voltages listed are rated motor voltages. The current listed shall be permitted for system voltage ranges of 110

to 120, 220 to 240, 440 to 480, and 550 to 600 volts. Motors rated at 208v ac should increase the 230 volt column figures by 10%.

For motors that are wound for single or double phase operation, use the nameplate rating. For older slip ring motors or models that have secondary windings be sure to obtain both primary and secondary current ratings. Secondary windings may also need separate conductors or cables when updating the electrification.

Single vs. Multiple Cranes

The procedures used to size single cranes are different from those used to size multiple cranes.

Single Units

1. For one motor, use 100% of the motor nameplate full load ampere rating.
2. For multiple motors on a single crane, the minimum ampacity of the power supply conductors shall be 100% of the nameplate full-load ampere rating of the largest motor or group of motors for any single crane motion plus 50% of the nameplate full-load amp rating of the remaining motors.

Multiple Units

1. For multiple cranes supplied by a common conductor, first estimate the individual unit amp load as in Step 2 of Single Units. Then multiply the total amp load of all units by the following table.

2. Additional loads such as heating, lighting, or air conditioning for cabs of large overhead cranes shall be provided for by adding the amperage load of this material to the motor load.

Demand Factors

Number of Cranes	Demand Factor
2	0.95
3	0.91
4	0.87
5	0.84
6	0.81
7	0.78

Determining Voltage Drop

After categorizing the units and totaling the electrical load, we are ready to size the conductor and calculate the voltage drop to confirm the proper selection. Use the following problem illustration to assist in selecting and sizing the proper HD conductor for your system.

For example, use a crane runway of 800 feet in length, two cranes on the runway, each with motors rated at 100 h.p. for the hoist, 10 h.p. on the trolley and two 10 h.p. motors on the bridge. The operation is heavy duty and the ambient temperature reaches 100°F in the summer. The supply voltage is 460 vac, 3 phase 60 cycle. The units are radio controlled from the floor.

The total amperage load for each unit is:

- (1) 100 h.p. hoist @ 124 amp x 100% 124.0 amps
- (1) 10 h.p. trolley @ 14 amp x 50% 7.0 amps
- (2) 10 h.p. bridge @ 14 amp x 50% 14.0 amps
- 145.0 amps

The total amp load for each unit is 145. The runway load for two cranes is then reduced by the Demand Factor from the table above.

$$145 + 145 = 290 \times 0.95 = 275.5 \text{ amps.}$$

According to CMAA, the voltage drop to the unit motors shall not be more than 3% from the power taps to the load at the farthest point on the conductor run. To determine the voltage drop use the appropriate formula in the following table.

- V = Voltage drop
- L = Distance in feet from power feed to end of conductor
- I = Total amperes drawn as determined by the Horsepower Conversion Table on page 2.
- Z = ac impedance from the Conductor Engineering Data Table below
- R = dc resistance from the Conductor Engineering Data Table below

Current Type	Formula
AC 3 phase 60 cycle	$V = L \times I \times Z \times 1.73$
DC 2 wire system	$V = L \times I \times R \times 2$

Based on the amp load, select the HD-500-3 conductor to use in the voltage drop calculation. From the AC 3 phase formula, we have the distance (L) = 400 ft., the total amp draw (I) = 275.5 amps, and the ac impedance value (Z) = 0.000070.

Putting these values into the formula, $V = L \times I \times Z \times 1.73$, the voltage drop (V) is:

$$V = 400 \times 275.5 \times 0.000070 \times 1.73 = 13.34$$

To obtain the *percentage* of voltage drop, divide the voltage drop figure (13.34) by the supply voltage.

$$13.34 \div 460 = 0.029 \text{ or } 2.9\%$$



This is within the CMAA recommended 3% voltage drop standard for crane runway conductors. The table below indicates the maximum voltage drop values that result in a 3% voltage drop to voltage supply ratio. When selecting a conductor, the voltage drop should be equal or less than the values shown.

Maximum Allowable Voltage Drop

Supply Voltage	Voltage Drop (V)
460v ac	13.8
230v ac or dc	6.9
575v ac	17.2

Ambient Temperature Adjustment

If the conductors are to be located where the ambient air temperature is unusually high, the current carrying capacity of the conductor is reduced. For those cases, multiply the current capacity of the selected conductor by the derating factor in the following table.

Temperature Derating Table

Ambient Air Temperature	Derating Factor
100°F	95%
130°F	75%
160°F*	50%

* At this ambient temperature it will be necessary to use the higher rated conductor cover, XHT rated at 280°F.

Conductor Engineering Data Table

Conductor Bar Number	Description	Weight per 20 ft. section (lbs.)	Continuous Current Rating (AC)	Coefficient of Linear Expansion per °F	Resistance		MCM
					AC (Z) Ohms/ft.	DC (R) Ohms/ft.	
HD-500-3	Extruded Aluminum with stainless steel cap	12.6	500	.000013	.000070	.000044	425.3
HD-1000-3	Extruded Aluminum with stainless steel cap	33.0	1000	.000013	.000040	.000014	1311.4
HD-1500-3	Extruded Aluminum with stainless steel cap	43.8	1500	.000013	.000030	.000009	1916.2

Collector Sizing

In systems using high amperage conductors, there are many installations which have multiple crane bridges. Experience has shown that individual crane bridges vary in horse power rating and current draw. Therefore, it is very important to size the collectors for the individual crane bridges when multiple units are encountered.

Other factors to consider when selecting collectors include the Class of Service of the cranes, whether there are units which have magnet lifts, and whether electronic controls are used in the crane operation.

Cranes which are used in Class D, E, or F service will have heavier service requirements than those used in standby or standard operation. The mechanical wear on collectors is much greater when heavier loads, more lifts per hour, or multiple shifts are involved. For these situations, collectors with greater shoe wear and adequate current draw should be selected.

Whenever a crane is used with a magnet lift, the Crane Manufacturer's Association of America recommends that tandem collectors be used for safety reasons. No magnet load should ever be in danger of being dropped due to a skip in the runway electrification.

Since most electronic control systems run on lower voltages than the crane power circuit, and are subject to loss of signal due to corrosion or build-up of deposits on the conductors, control manufacturers recommend the use of tandem collectors for electronic circuits as well.

If the application calls for continuous use of the largest motor or motors when the unit is stationary, such as the hoisting motion on large loaders, there is the possibility of overheating the conductors. Contact the factory regarding derating of the collectors.

Expansion Gaps

Expansion gaps should be placed at intervals determined by 1) the expansion rate of the metal in the conductor, 2) the variation in ambient temperature which can occur at the conductor location over a full year of operation, and 3) the location of building expansion joints.

The HD conductor material is aluminum with a stainless steel cap on the running surface. Aluminum is the primary metal for calculating the total expansion. The expansion rate for aluminum is: 1.56"/100 ft./100°F.

The formula used to calculate the total conductor expansion is:

Total expansion (inches) = $1.56 \times X/100' \times Y/100^\circ\text{F}$,
 where X is the runway length in feet and Y is the total temperature variation in °F.

1. System Located Indoors

Calculate the expansion for a system that is 800 ft. in length, with an indoor temperature variation of 50°F.

Total Expansion = $1.56 \times 800'/100' \times 50^\circ\text{F}/100^\circ\text{F} = 6.24"$.

2. System Located Outdoors

Calculate the expansion for a system that is 950 ft. in length with an outdoor temperature variation of 110°F.

Total Expansion = $1.56 \times 950'/100' \times 110^\circ\text{F}/100^\circ\text{F} = 16.3"$

3. Determine the Number of Expansion Gap Assemblies

After calculating the actual expansion of the runway

conductor system, use the following rule of thumb to pick the number of expansion gap assemblies:

- A. Under 3" of expansion, use no expansion assemblies, but do install one anchor clamp assembly at the center of each conductor run.
- B. From 3" to 6" of expansion, use one expansion assembly in the center of the conductor run.
- C. From 6" to 9" of expansion, use two expansion assemblies in each conductor run. Locate them at 1/3 of the runway length in from each end.
- D. For systems with more than 9" of expansion, use one expansion assembly for each 3" of expansion.

4. Anchors

Anchor clamps or anchor pins are required at midpoint on all systems without expansion gaps and halfway between gaps and from gaps to the ends of systems with multiple gaps. See the *HD Installation Instructions* on anchor locations. *If anchors are not correctly placed and used, the expansion gap settings will be lost.*

The maximum gap setting for HD-500 systems is 3.5", and there are two 1.75" gaps to set. The maximum gap setting for the HD-1000 and HD-1500 systems is 3.25", and there is one gap to set.

See the HD Installation bulletins for specific instructions.

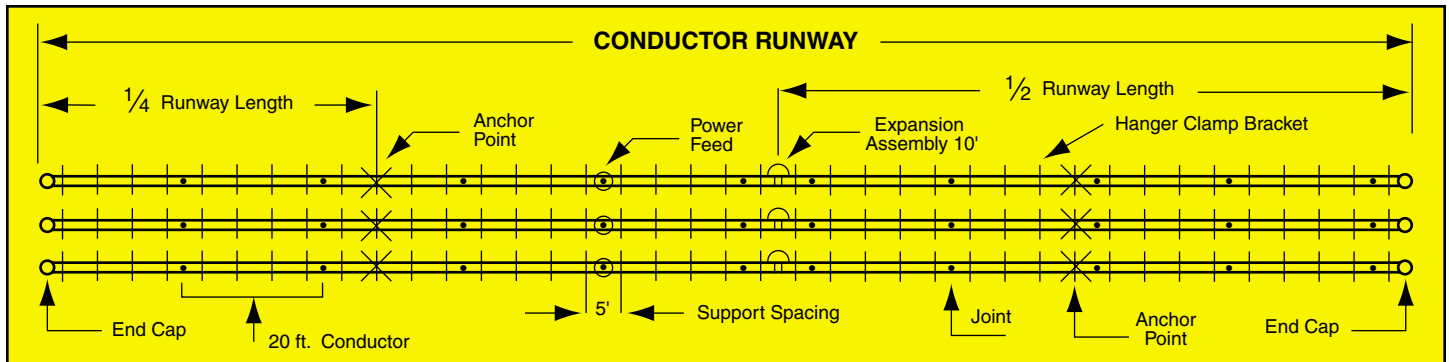

HD-500 Schematic Diagram

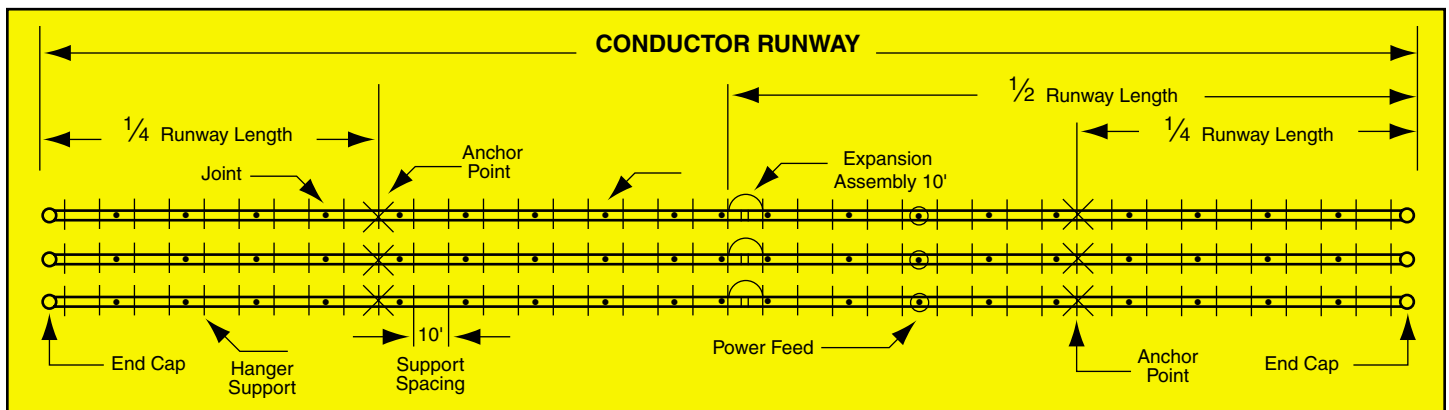

HD-1000 Schematic Diagram

Installation Dimensions — 500 Amp

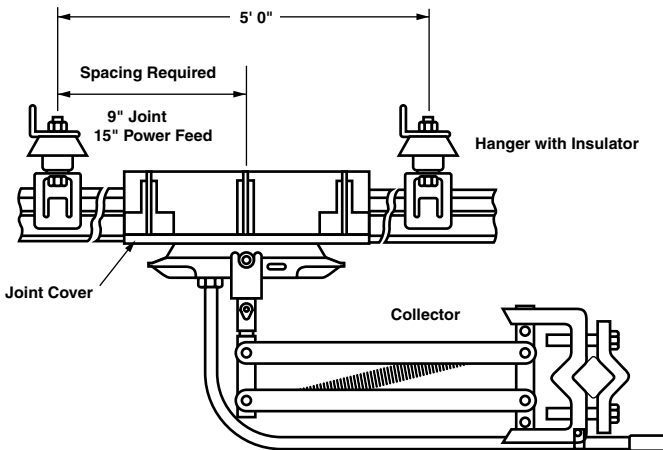

HD-500-3 System — Support Spacing Requirements

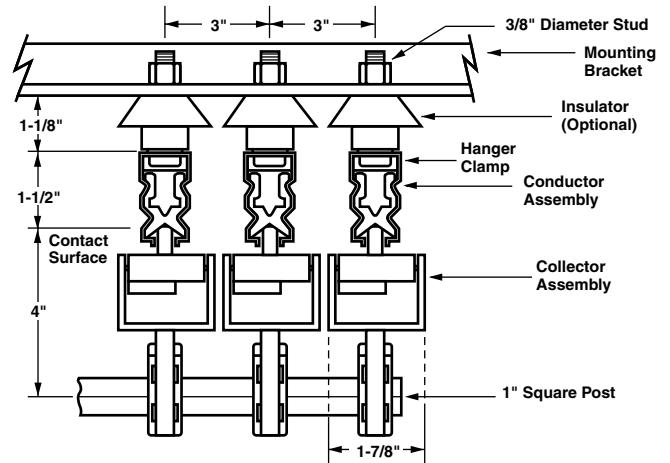

Typical System Installation — 500 Amp

Basic HD Conductors — 500 Amp

20-Foot Lengths Weight (Lbs)	Assembly Catalog Number		
	Indoor Use 160°F Max.	Outdoor Use 160°F with UV Additive	High Temperature Use 280°F Max.
12.6	HD-500-3	HD-500-3-SC	HD-500-3XHT

Collectors for 500 Amp Conductors

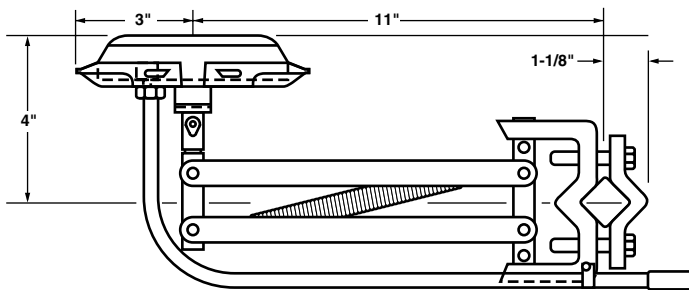

HDP-150-V5
Pantograph Collector, Single Shoe

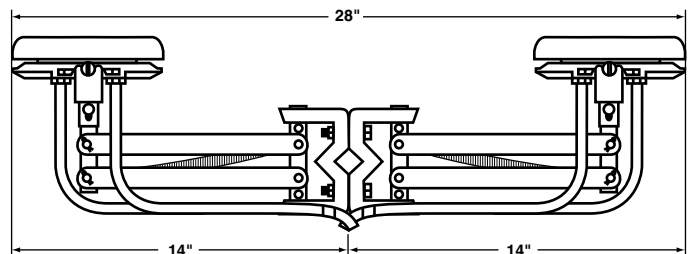

HDP-500-VT6
Pantograph Tandem Collector

HDP Series Pantograph Collector Assemblies

Catalog No.	Lbs.	Description
HDP-150-V5	2.5	150 amp Single Shoe — Vertical Mount
HDP-150-V5-BR	5.4	150 amp Single Shoe — Vertical, Bronze
HDP-150-L5	2.8	150 amp Single Shoe — Lateral Mount
HDP-300-VT5	5.1	300 amp Double Shoe — Vertical Mount
HDP-300-VT5-BR	9.9	300 amp Double Shoe — Vertical, Bronze
HDP-300-LT5	5.3	300 amp Double Shoe — Lateral Mount

HDP Series Pantograph Collector Assemblies

Catalog No.	Lbs.	Description
HDP-250-V6	2.7	250 amp Single Shoe — Vertical Mount
HDP-250-V6-BR	5.7	250 amp Single Shoe — Vertical, Bronze
HDP-250-LT6	2.8	250 amp Single Shoe — Lateral Mount
HDP-500-VT6	5.6	500 amp Double Shoe — Vertical Mount
HDP-500-VT6-BR	10.2	500 amp Double Shoe — Vertical, Bronze
HDP-500-LT6	5.7	500 amp Double Shoe — Lateral Mount

For special pigtail lengths, contact the factory.

Installation Dimensions — 1000 & 1500 Amp

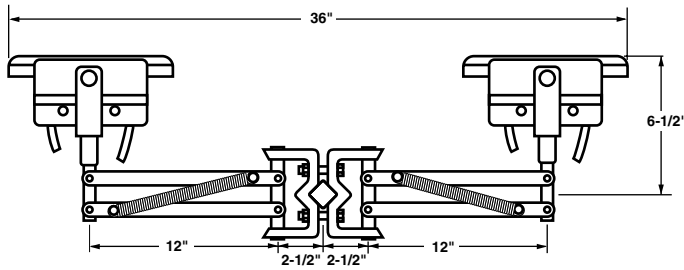

HD-1000-3 & HD-1500-3 Systems
Support Spacing Requirements

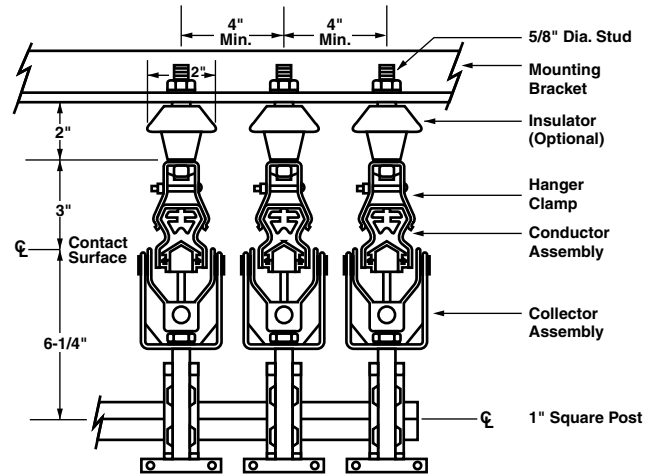

Typical System Installation
1000 & 1500 Amp

Basic HD Conductors — 1000 & 1500 Amp

20-Foot Lengths Weight (Lbs)	Assembly Catalog Number	
	Indoor Use	Outdoor Use
33.0	HD-1000-3	HD-1000-3-SC

20-Foot Lengths Weight (Lbs)	Assembly Catalog Number	
	Indoor Use	Outdoor Use
43.8	HD-1500-3	HD-1500-3-SC

Collectors for 1000 & 1500 Amp Conductors

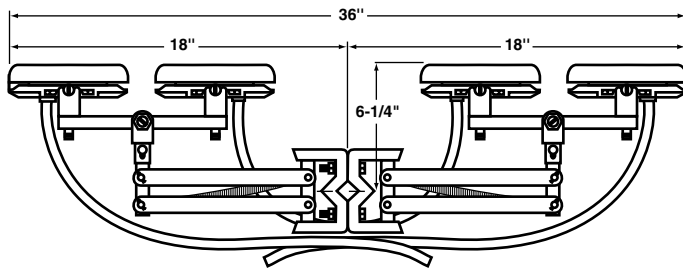

HDP-1000-VT6
Pantograph Collector, Double Shoe

HDP Series Pantograph Collector Assemblies

Catalog No.	Lbs.	Description
HDP-250-V6	2.7	250 amp Single Shoe — Vertical Mount
HDP-250-V6-BR	5.7	250 amp Single Shoe — Vertical, Bronze
HDP-250-LT6	2.8	250 amp Single Shoe — Lateral Mount
HDP-500-VT6	5.6	500 amp Double Shoe — Vertical Mount
HDP-500-VT6-BR	10.2	500 amp Double Shoe — Vertical, Bronze
HDP-500-LT6	5.7	500 amp Double Shoe — Lateral Mount
HDP-1000-VT6	11.3	1000 amp 4-Head — Vertical Mount

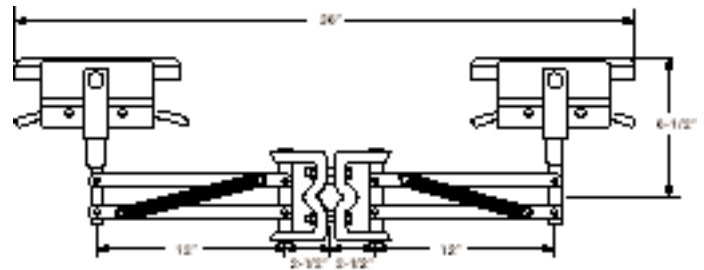

HD-600-TPC
Pantograph Collector, Double Shoe

HD Series Pantograph Collector Assemblies

Catalog No.	Lbs.	Description
HD-300-PC	6.1	300 amp Single Shoe — Vertical Mount
HD-600-TPC	12.3	600 amp Double Shoe — Vertical Mount

For special pigtail lengths, contact the factory.

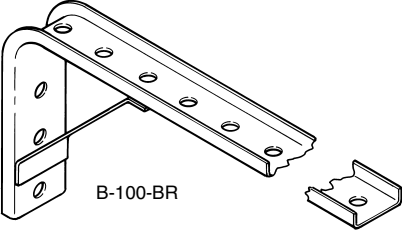
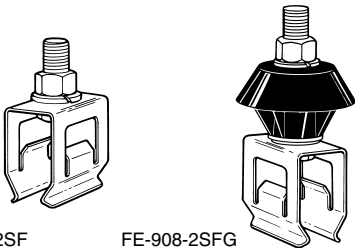
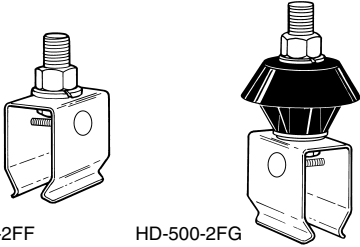
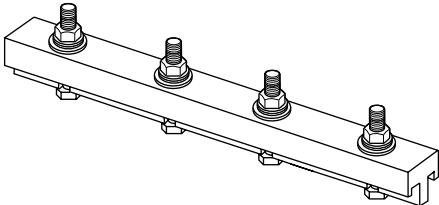
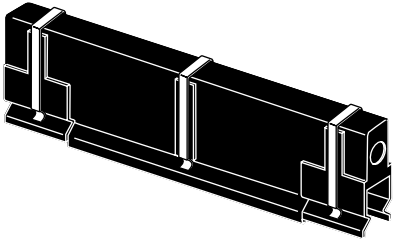
HD-500 Systems	Catalog Number	Weight Pounds	Description
 <p>B-100-BR</p>	<p>B-100-BR7B B-100-BR13B</p> <p>HD-T1BR-B1-500 HD-T1BR-W1-500</p>	<p>1.18 1.57</p> <p>4.78 4.78</p>	<p>Angle Brackets for Web Mounting Bracket with gusset support, 14-1/4" long. Bracket with gusset support, 20-1/4" long.</p> <p>Welded Angle Iron Brackets <i>3/16" x 1-1/2" x 24". Number of hanger holes determined by conductor runs. Minimum web height 10". Bracket drawings available.</i> Bracket with red primer, 8" vertical leg drilled for two 5/8" bolts spaced 3" apart. Bracket without primer or mounting holes.</p>
 <p>FE-908-2SF FE-908-2SFG</p>	<p>FE-908-2SF FE-908-2SFE FE-908-2SFS</p> <p>FE-908-2SFG FE-908-2SFFG FE-908-2SFGS</p>	<p>.11 .11 .11</p> <p>.20 .20 .20</p>	<p>Snap-In Hanger Assemblies Zinc plated steel hanger. Epoxy coated steel hanger. Stainless steel hanger with stainless steel hardware. Zinc plated steel hanger with insulator. Epoxy coated steel hanger with insulator. Stainless steel hanger with insulator and stainless steel hardware.</p>
 <p>HD-500-2FF HD-500-2FG</p>	<p>HD-500-2FF HD-500-2FFE HD-500-2FG HD-500-2FFG</p>	<p>.24 .24 .32 .32</p>	<p>Cross Bolt Hanger Assemblies Zinc plated steel hanger. Epoxy coated steel hanger. Zinc plated steel hanger with insulator. Epoxy coated steel hanger with insulator.</p>
	<p>HD-500-2FEA</p>	<p>.36</p>	<p>Anchor Clamp Assemblies <i>Clamps on both sides of a hanger at selected locations.</i> Two-piece epoxy coated anchor set.</p>
	<p>HD-500-1D</p>	<p>.37</p>	<p>Bolted Joint Assembly Installs at the junction of two conductors. The grooved header bar with four bolts provides perfect alignment and strong holding power. Estimate joint covers for all joints except when using a power feed.</p>
	<p>HD-500-3ER</p>	<p>.37</p>	<p>Joint/Power Feed Cover Use the joint cover with each bolted joint assembly. A cover is supplied with each power feed assembly. There are knockouts at each end for cable entry.</p>

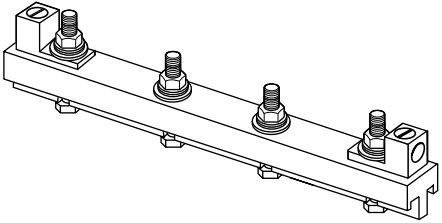
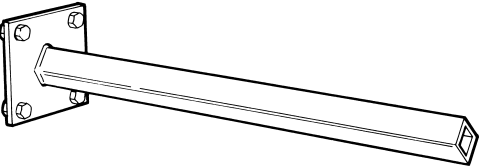
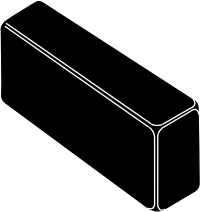
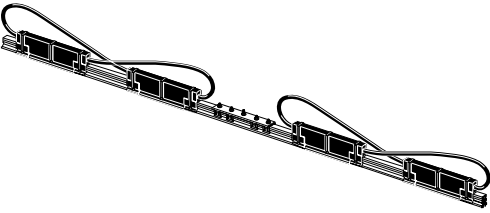
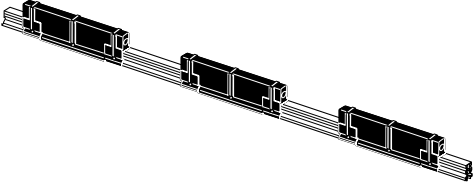
HD-500 Systems	Catalog Number	Weight Pounds	Description
	HD-500-3CP	.84	<p>Power Feed Assembly with Cover Takes the place of a bolted joint at a selected power feed location. The part number includes an HD-500-3ER cover. Each lug holds up to a 1/0 power cable.</p>
 <p data-bbox="204 747 358 768">Bolts: 3/8 - 16 x 1-1/2"</p>	FC-TB1	3.25	<p>Collector Mounting Post Mounting Post with Hardware — 18" long. Mounting plate is 4" square with 3" hole spacing for HDP-Series Collectors. Contact factory for special lengths or finishes.</p>
	HD-500-3GC	.05	<p>End Cover Flexible PVC End Cover, black. For all HD-500-3 conductors.</p>
	<p>HD-500-3H10 HD-500-3H10-SC HD-500-3H10XT</p>	<p>12.0 12.0 12.0</p>	<p>Expansion Gap Assembly <i>Each assembly consists of a ten-foot conductor bar, insulating cover, guide assembly, two gap openings, four power feeds and jumper cables. Anchor sets and instructions are included with the assembly.</i></p> <p>Expansion section, orange PVC cover. Same with gray PVC outdoor cover. Same with yellow polycarbonate high temperature cover. Rated to 280°F.</p>
	<p>HD-500-3IS10 HD-500-3IS10-SC HD-500-3IS10-XT</p>	<p>10.0 10.0 10.0</p>	<p>Isolating Section Assembly <i>Each assembly consists of a ten-foot section of conductor with two air gaps bridged with phenolic gap pieces and a power feed for the center section. Center section is longer than a tandem collector to prevent bridging power across the isolation gap.</i></p> <p>Isolating section, orange PVC cover. Same with gray PVC outdoor cover. Same with yellow polycarbonate high temperature cover. Rated to 280°F.</p>
	EJC	1.2	<p>Electric Joint Compound 1 pint size. Estimate one for each 500 ft. of 3 phase conductor run.</p>

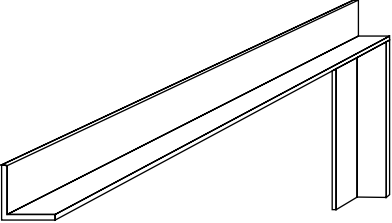
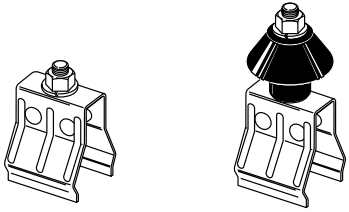
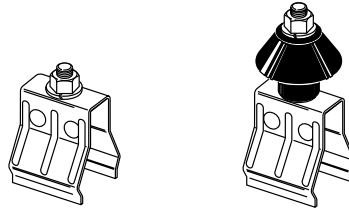
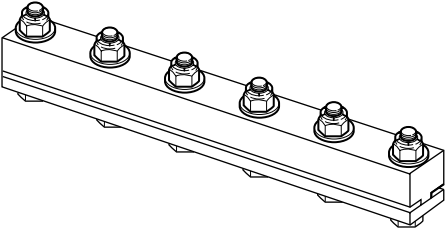
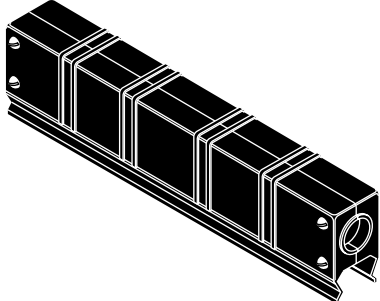
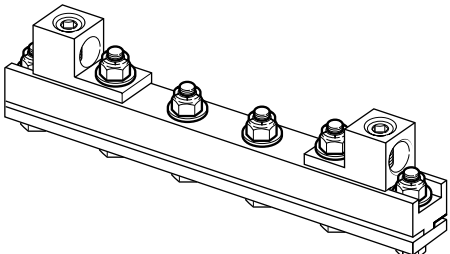
HD-1000 & 1500 Systems	Catalog Number	Weight Pounds	Description
	HD-T1BR-B-1000	7.0	<p>Welded Angle Iron Brackets <i>3/16" x 2" angle iron material. Number of hanger holes determined by conductor runs. Bracket drawings available. Minimum web height 10".</i></p> <p>24" Bracket with red primer, 8" vertical leg drilled for two 5/8" bolts spaced 3" apart.</p> <p>Same as above without primer or mounting holes.</p> <p>27" Bracket with red primer, 8" vertical leg drilled for two 5/8" bolts spaced 3" apart.</p> <p>Same as above without primer or mounting holes.</p>
	HD-T1BR-W-1000	7.0	
	HD-T1BR-B-27	7.6	
	HD-T1BR-W-27	7.6	
	HD-1000-2F HD-1000-2FE HD-1000-2FG HD-1000-2FGE	.84 .86 1.24 1.26	<p>Bolted Hanger Assemblies <i>All hangers have 5/8" mounting bolts.</i></p> <p>Zinc plated steel hanger.</p> <p>Epoxy coated steel hanger.</p> <p>Zinc plated steel hanger with insulator.</p> <p>Epoxy coated steel hanger with insulator.</p>
	HD-1000-2FEA HD-1000-2FGEA	.86 1.26	<p>Anchor Clamp Assemblies <i>All anchors have 5/8" mounting bolts. Anchors are bracket mounted and replace hangers at designated locations.</i></p> <p>Epoxy coated, no spacers on cross-bolts.</p> <p>Epoxy coated with insulator, no spacers.</p>
	HD-1000-3D	1.98	<p>Bolted Joint Assembly Grooved header bar and six bolts provides for perfect alignment and strong holding power. For both HD-1000 and HD-1500 systems. Estimate joint covers separately.</p>
	HD-1000-3ER HD-1500-3ER	1.3 1.43	<p>Joint/Power Feed Cover Use with HD-1000 systems. Use with HD-1500 systems.</p>
	HD-1000-3CP HD-1500-3CP	3.48 3.62	<p>Power Feed Assembly with Cover <i>Takes the place of a bolted joint at a selected power feed location. The part number includes an HD-1000-3ER or HD-1500-3ER cover.</i></p> <p>Two 350 mcm cable lugs for HD-1000 systems.</p> <p>Two 500 mcm cable lugs for HD-1500 systems.</p>

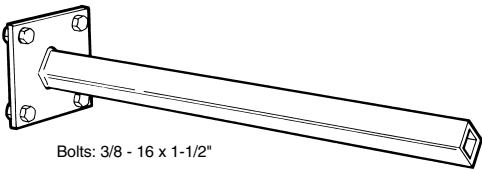
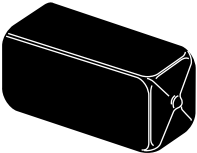
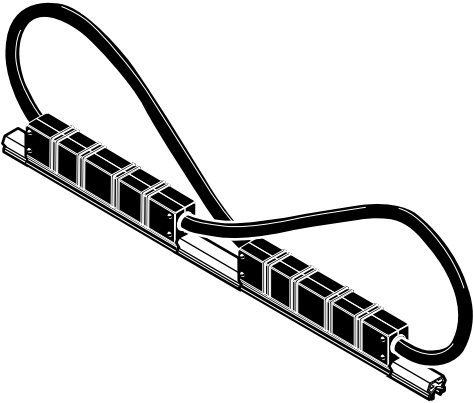
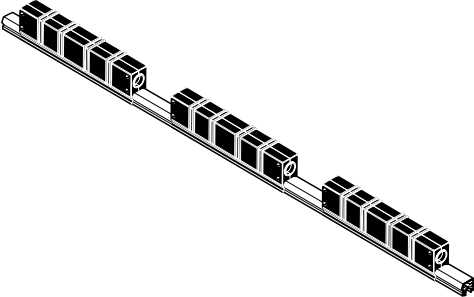
HD-1000 & 1500 Systems	Catalog Number	Weight Pounds	Description
 <p>Bolts: 3/8 - 16 x 1-1/2"</p>	FC-TB1	3.25	<p>Collector Mounting Post</p> <p>Mounting post with hardware — 18" long. Mounting plate is 4" square with 3" hole spacing for HDP-Series and HD-Series Collectors. Contact factory for special lengths or finishes.</p>
	<p>HD-1000-3GC</p> <p>HD-1500-3GC</p>	<p>.14</p> <p>.16</p>	<p>End Cover</p> <p><i>Flexible PVC, black.</i></p> <p>Cover for HD-1000 systems.</p> <p>Cover for HD-1500 systems.</p>
	<p>HD-1000-3H10</p> <p>HD-1000-3H10-SC</p> <p>HD-1500-3H10</p> <p>HD-1500-3H10-SC</p>	<p>38.5</p> <p>38.5</p> <p>44.0</p> <p>44.0</p>	<p>Expansion Gap Assemblies — 10 Foot Section</p> <p><i>Each assembly consists of 10 feet of conductor, insulating cover, guide assembly, gap opening, power feeds and jumper cables. Anchor sets and instructions are included in the assembly.</i></p> <p>Assembly with orange cover for HD-1000.</p> <p>Assembly with sun cover for HD-1000.</p> <p>Assembly with orange cover for HD-1500.</p> <p>Assembly with sun cover for HD-1500.</p>
	HD-EXP-WSA	1.9	<p>Wire Support</p> <p>Wire support assembly for HD-1000 and HD-1500 expansion gap jumper cables.</p>
	<p>HD-1000-3IS10</p> <p>HD-1000-3IS10SC</p> <p>HD-1500-3IS10</p> <p>HD-1500-3IS10SC</p>	<p>20.0</p> <p>20.0</p> <p>20.0</p> <p>20.0</p>	<p>Isolation Assemblies — 10 Foot Section</p> <p><i>Each assembly consists of 10 feet of conductor, insulating cover, phenolic insulated gap pieces, and a power feed for the center section.</i></p> <p>Assembly with orange cover for HD-1000.</p> <p>Assembly with sun cover for HD-1000.</p> <p>Assembly with orange cover for HD-1500.</p> <p>Assembly with sun cover for HD-1500.</p>
	EJC	1.2	<p>Electric Joint Compound</p> <p>1 pint size. Estimate one for each 260 feet of 3 phase conductor run.</p>

Expansion Gap Dimensions for Hanger and Bracket Locations

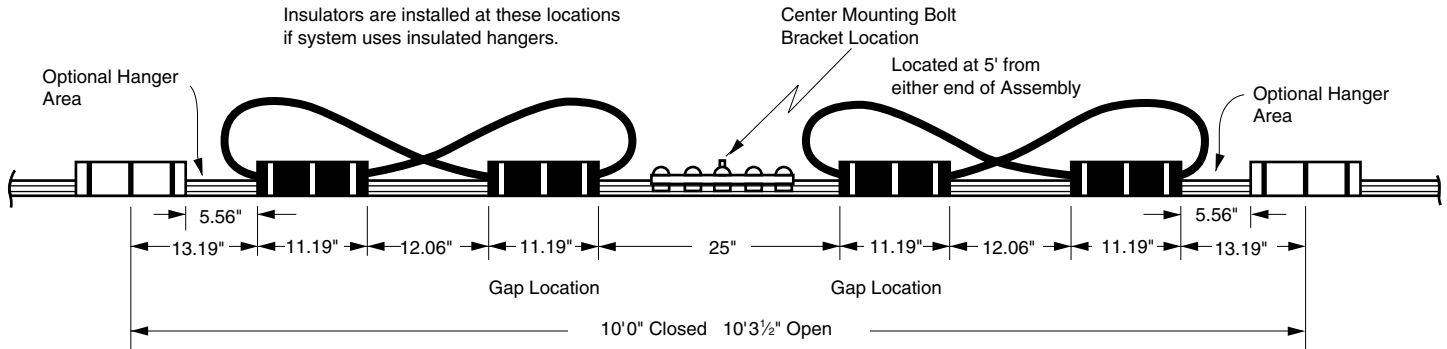

HD-500-3H10

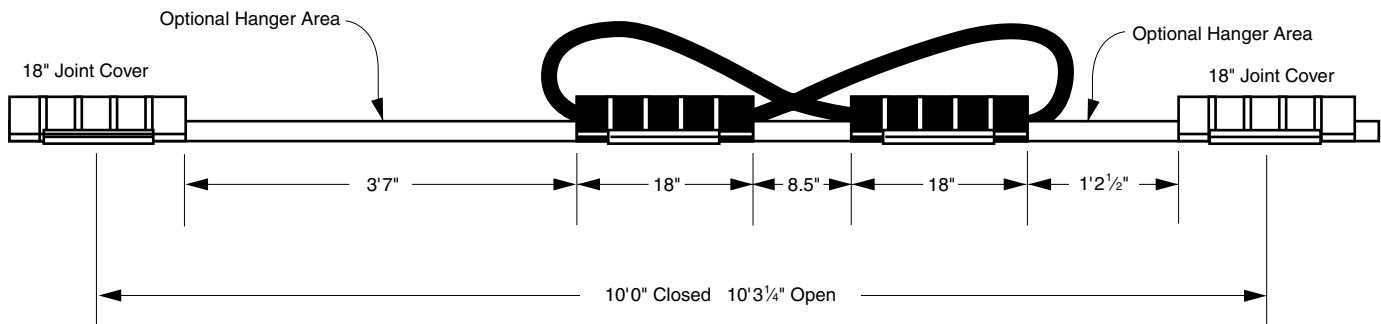

HD-1000-3H10 & HD-1500-3H10

Heated Conductor Systems for De-Icing Control

Ice build-up on outdoor overhead cranes can cause the collectors to skip out of the conductor. To prevent this from happening, Duct-O-Wire provides a thermostatically controlled heater cable system that is engineered for each specific application.

The heater cable is installed in the various conductors, and the circuit and cable size are formulated specifically to match the system length. The heater cable is constructed in such a way that individual conductor sections can be replaced without removing the entire heater cable.

Duct-O-Wire maintains drawings of all heated systems in case replacement sections are needed to fit the original system. Records are also vital in case of additions to the system or revisions to the heater cable circuit become necessary.

Contact the Duct-O-Wire sales department for details and pricing of the heated systems.



Duct-O-Wire representatives and distributors are located throughout the U.S. and Canada. Call the factory for the representative or distributor closest to you.

Brochure HD-98
Copyright 1998
Printed in U.S.A.