



DUCT-O-BAR

Figure 8 Electrical Conductor Systems

**For Overhead Cranes, Trolleys, Monorails, Hoists,
Conveyors, Automatic Stacker-Retrieval Systems...
any Application that Requires a Reliable, Safe, and
Economical Moving Power System.**

- 90 AMP Rolled Galvanized Steel
- 110 AMP Rolled Galvanized Steel
- 160 AMP Rolled Stainless Steel —
Copper Laminated
- 250 AMP Rolled Copper — Steel Laminated
- 350 AMP Rolled Electrolytic Copper
- 500 AMP Extruded Electrolytic Copper

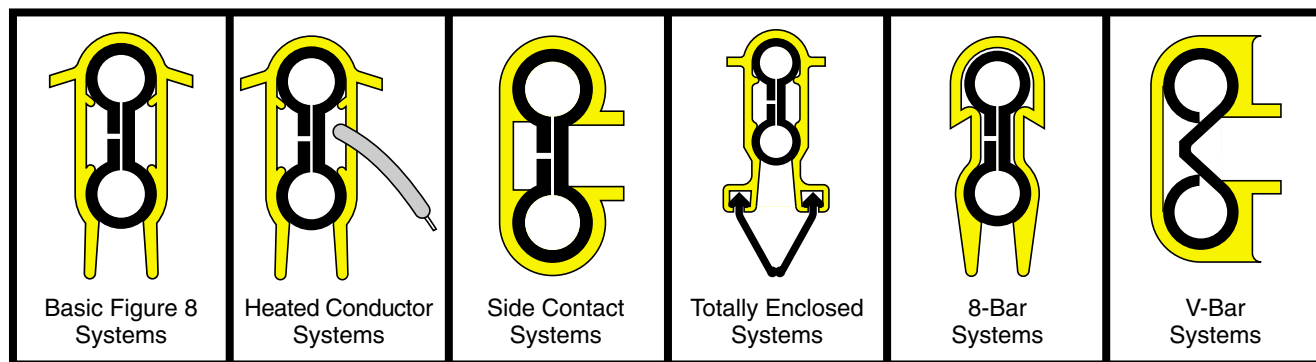

CAUTION

MAKE CERTAIN POWER SUPPLY IS DISCONNECTED BEFORE INSTALLING, REPAIRING, OR WORKING IN THE PROXIMITY OF ANY ELECTRICAL SYSTEM. ONLY QUALIFIED ELECTRICAL PERSONNEL SHOULD INSTALL OR REPAIR THESE PRODUCTS.

www.duct-o-wire.com

P.O. Box 519

Corona, California 92878-0519

Phone: 909-735-8220; 800-543-3885; 800-735-1922

Fax: 909-735-2372; 800-752-6001; 800-735-0857

1351 W. Second Street

Oconomowoc, Wisconsin 53066

Phone: 262-567-2288

Fax: 262-567-0857

379 Davis Road, Unit #3

Oakville, Ontario, Canada L6J 2X2

Phone: 905-844-1791; 800-361-9473

Fax: 905-844-2533; 800-663-0933



File # E29805
Contr. 678L

Approved
in Canada

Conductor Bar Selection

Determining Ampere Load

The conductor selected must be large enough to carry the necessary ampere load safely without undue heating. To compute the ampere load, proceed as follows:

1. List the horsepower of all motors used in the application.
2. Determine the voltage and type of current that will feed the conductor. For example: 230v dc 2 wire; 460v ac 3 phase; etc.
3. Refer to the Horsepower Conversion Table on page 3 and convert the horsepower to amperes.
4. Prepare the ampere load figure that will be used to size the conductors as follows:

List the full load ampere rating of each motor used on the crane or monorail unit. Determine the duty cycle from the following paragraphs and apply the corresponding factor.

Light Duty — Class A and B Crane Service

Standby or infrequent use. Up to two motors started at a time. Two to five lifts per hour. Use a factor of 90% of the calculated ampere load.

Average Duty — Class C Crane Service

Moderate use during the work day. Five to ten lifts per hour. Not over 50% of the lift at rated capacity. Use a factor of 100% of the calculated ampere load.

Heavy Duty — Class D Crane Service

Used continually during the work day and usually for more than one shift. Loads of 50% of rated capacity or more handled constantly during the work period. Use a factor of 110% of the calculated ampere load.

Severe Duty — Class E and F Crane Service

Used continually for two or more work shifts a day for loads approaching 100% of capacity. Use a factor of 120% of the calculated ampere load. Due to the mechanical considerations on severe duty use, contact the factory engineering group when selecting the conductor system for this application.

5. If the conductors are to be located where the ambient air temperature is unusually high, the current carrying capacity of the conductor is reduced. Multiply the current capacity of the selected conductor by the derating factor in the following table.

Temperature Derating Table

Ambient Air Temperature	Derating Factor
100°F	95%
130°F	75%
160°F*	50%

* At this ambient temperature it will be necessary to use the higher rated conductor cover, XHT rated at 280°F.

Determining Voltage Drop

According to CMAA, the voltage drop to the unit motors shall not be more than 3% from the power taps to the load at the farthest point on the conductor run. To determine the voltage drop use the appropriate formula in the following table.

Current Type	Formula
AC 3 phase 60 cycle	$V = L \times I \times Z \times 1.73$
AC 1 or 2 phase 60 cycle	$V = L \times I \times Z \times 2$
DC 2 wire system	$V = L \times I \times R \times 2$

V = Voltage drop

L = Distance from power feed to end of conductor

I = Total amperes drawn as calculated from conversion charts

Z = ac impedance

R = dc resistance

See Conductor Engineering Data Table on page 4 for values of Z and R.

Divide voltage drop by system voltage to get the percent of voltage drop.

Maximum voltage drops that are 3% of various supply voltages are as follows:

Supply Voltage	Voltage Drop (V)
460v ac	13.8
230v ac or dc	6.9
575v ac	17.2

Volts lost that are equal to or less than the above values when using the formulas above will help in selecting the correct conductor.

Conductor Selection Example

Given a 300 foot runway, power fed at the center, using 460 volt, 3 phase, 60 cycle power supplied to a bridge crane — there is a 40 h.p. hoist motor, a 20 h.p. bridge motor, and a 5 h.p. trolley motor. The operation is **Average Duty**. Ambient temperature varies from 50°F in winter to 90°F in summer on this **Indoor** installation.

Step 1 — Determining Ampere Load

See *National Electric Code article 610-14(e)* for determining motor loads where there are multiple motors on a single crane. Then from the Horse Power Conversion Table 460v column (right):

40 h.p. hoist motor — 52 amps @ 100% = 52 amps
 20 h.p. bridge motor — 27 amps @ 50% = 13.5 amps
 5 h.p. trolley motor — 7.6 amps @ 50% = 3.8 amps

The total current load is 69.3 amperes.

With Average Duty cycle, the current load is factored at 100%. Normal ambient conditions of 50°F to 90°F require no temperature derating. Selecting a 90 amp conductor caused a voltage drop of 4.3% using the formula. Since this is unsatisfactory, use a 110 amp conductor (FE-908) for Step 2.

Step 2 — Determining Voltage Drop

Use the AC 3 phase formula on page two.

$V = L \times I \times Z \times 1.73$ where:
 L = 150 ft. (Distance to the end of the runway from the center power feed.)
 I = 69.3 amperes
 Z = .0008 for 110 amp conductor (From the Conductor Engineering Data Table, page 4.)
 1.73 = 3 phase constant

$$V = 150 \times 69.3 \times .0008 \times 1.73 = 14.4 \text{ volts}$$

$$14.4/460 = 3.1\%$$

Since this voltage drop only occurs at the farthest end when two or more motors are started simultaneously, exceeding the 3% voltage drop goal by only 0.1% will not cause a problem.

Horsepower Conversion Table

H.P.	3 Phase AC — 60 Cycle Amperes			Direct Current Amperes
	230v	460v	575v	230v
1/2	2	1	.8	2.7
3/4	2.8	1.4	1.1	3.8
1	3.6	1.8	1.4	4.7
1-1/2	5.2	2.6	2.1	6.6
2	6.8	3.4	2.7	8.5
3	9.6	4.8	3.9	12.2
5	15.2	7.6	6.1	20
7-1/2	22	11	9	29
10	28	14	11	38
15	42	21	17	55
20	54	27	22	72
25	68	34	27	89
30	80	40	32	106
40	104	52	41	140
50	130	65	52	173
60	154	77	62	206
75	192	96	77	255
100	248	124	99	341
125	312	156	125	425
150	360	180	144	506
200	480	240	192	675

Ampere Load Calculations for Multiple Units

For information about sizing ampere loads for multiple cranes on the same runway, see Article 610-14 (e) of the National Electrical Code for the demand factors. This article also covers additional loads on the bridge cranes other than motor loads.

Induction Type Squirrel Cage and Wound Rotor Motors

The Horsepower Conversion Table is taken from the 1996 NEC Article 430. The values are for motors running at usual speeds with normal torque characteristics. Motors built for especially low speeds or high torques may require more running current, and multi-speed motors will have

full-load current varying with speed. In these cases, use the higher nameplate current rating.

The voltages listed are rated motor voltages. The current listed shall be permitted for system voltage ranges of 110 to 120, 220 to 240, 440 to 480, and 550 to 600 volts. Motors rated at 208v ac should increase the 230 volt column figures by 10%.

For motors that are wound for single or double phase operation, use the nameplate rating. For older slip ring motors or models that have secondary windings be sure to obtain both primary and secondary current ratings. Secondary windings may also need separate conductors or cables when updating the electrification.



Conductor Engineering Data Table

Conductor Bar No.	Description	Weight per 10' section lbs.	Ampere Rating		Coefficient of Linear Expansion per °F	Resistance Factor		Circular Mills
			Continuous	Intermittent*		AC (z) ohms/ft.	DC (R) ohms/ft.	
FE-758	Galvanized Steel	4.5	90	135	.000007	.0011	.00072	130,000
FE-908	Galvanized Steel	6.5	110	165	.000007	.0008	.0005	189,000
FE-1608	Stainless/Copper Laminate	6.5	160	240	.000008	.000144	.0001	188,000
FE-2008	Copper/Steel Laminate	6.25	250	350	.000008	.000142	.0001	189,000
FE-3008	Rolled Copper	6.75	350	530	.000009	.000085	.000058	188,000
FE-5008	Extruded Copper	11.5	500	750	.000009	.000065	.000033	315,000

* Intermittent Service Rating is determined for one minute on, one minute off operation.

Miscellaneous Applications

Curves

Duct-O-Bars, except the Totally Enclosed System, can be bent to form curved sections without damaging the insulating cover or conductor. Bends with a five-foot radius or greater can be done in the field by using a fly wheel, monorail beam, or similar object to bend the conductor to approximately the necessary radius. Hangers used on curved sections must be placed at intervals of 2-1/2 feet maximum — and closer if required. Use B-100 cross bolt clamp type hangers and P-Series collectors.

The minimum spacing between conductors on curves is three inches.

For curves of five-foot radius or more, use five-inch collector shoes. For curves of less than five-foot radius use three-inch collector shoes; also consult the factory for additional information.

Discontinuous Circuits

On discontinuous circuits a pickup guide assembly must be installed to ensure that the self-centering type collectors engage and disengage the conductor bar. The pickup guide (FE-2JNN3 is illustrated) must have its own support point.

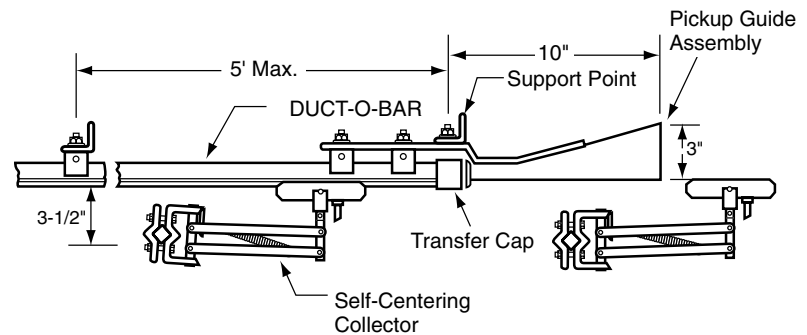

Interlocks, Switches, or Fixed Gaps

The maximum fixed gap occurring at interlocks is one-inch when using 100 amp P-Series collectors and 1/2 inch when using 40 amp collectors. Use transfer caps as shown to ensure that the collector brushes transfer evenly and smoothly. Also round both ends of the contact brushes to facilitate the transfer. Use clamp type hangers only. When both interlocks and curves of less than a four-foot radius are encountered, the tandem 40 amp collector is recommended.

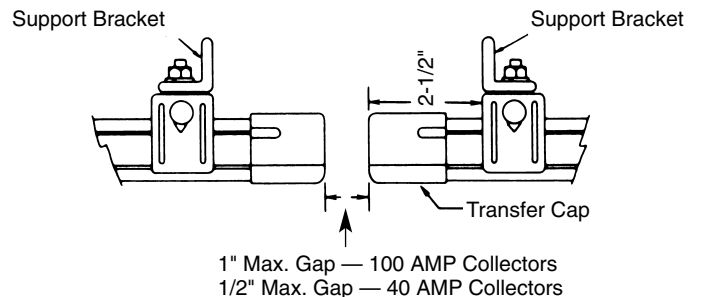

Other Special Applications

Consult the factory for recommendations on applications such as de-icing systems, totally enclosed systems, and other systems not covered here.

Expansion Gaps

Expansion gaps should be placed at intervals determined by 1) the expansion rate of the metal in the conductor selected, and 2) the variation in temperature that will occur at the conductor location over a full year of operation.

1. Steel Conductor Systems

Given that steel conductors expand 1" for every 150' of runway with a temperature change of 100°F over a full year of operation, put the length of the runway and the maximum temperature change for the system to be used into the following formula:

$$\text{Total Steel Expansion (inches)} = X/150' \times Y/100^\circ\text{F}$$

where *X* is the runway length and *Y* is the 12 month temperature variation.

Example: A 450' long steel conductor (*X*) installed in a building with an indoor temperature change of 40°F (*Y*).

$$\text{Total Expansion} = 450'/150' \times 40^\circ\text{F}/100^\circ\text{F} = 1.2".$$

(See Section 3.)

2. Copper Conductor Systems

Given that copper conductors expand 1" for every 100' of runway over a 100°F temperature change at the conductor over a full year of operation, put the length of the runway and the maximum temperature change for the system to be used into the following formula:

$$\text{Total Copper Expansion (inches)} = X/100' \times Y/100^\circ\text{F}$$

Example: A 300' long copper conductor system (*X*) installed outdoors with an anticipated temperature fluctuation of 80°F (*Y*).

$$\text{Total Expansion} = 300'/100' \times 80^\circ\text{F}/100^\circ\text{F} = 2.4".$$

(See Section 3.)

3. Determine the Number of Expansion Gap Assemblies

After calculating the actual expansion of the runway conductor system, use the following rule of thumb to pick the number of expansion gap assemblies:

- Under 1" of expansion, use no expansion assemblies. Install one anchor clamp set at the center of the conductor run.
- From 1" to 2" of expansion, use one expansion assembly in the center of the conductor run.
- From 2" to 4" of expansion, use two expansion assemblies. Locate them at 1/3 of the runway length in from each end.
- For systems with more than 4" of expansion, use one expansion gap assembly for each 2" of expansion.

4. Anchors

Anchor clamps are required at midpoint on all systems without expansion gaps and halfway between gaps and from gaps to the end of systems with multiple gaps. See the *Figure 8 Installation Instructions* on anchor locations.

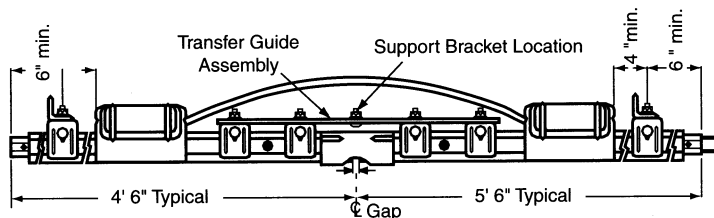

The maximum gap opening for all ten foot Figure 8 expansion gap assemblies is 1-3/4 inches.

Expansion assemblies are also required at building expansion joints.

Conductor Assembly Selection

Duct-O-Wire Figure 8 Conductor Bars are furnished as assemblies consisting of a ten-foot long conductor bar rated at 600 volts, an insulating cover, splice cover, and connector pins or joint clamps as applicable.

The insulating cover must be appropriate for the environment — indoor, outdoor, or high temperature — in which the conductor is to operate.

Indoor systems are for use in ambient temperatures up to 160°F. They have an Orange PVC Insulating Cover. They are not recommended for outdoor use in direct sunlight.

Outdoor systems are for use in direct sunlight and ambient temperatures up to 160°F. They have a Gray PVC Insulating Cover with an ultraviolet additive.

High temperature systems are for use in ambient temperatures up to 280°F. They have a Yellow Lexan Insulating Cover.

From the table to the right, you can select the basic (FE) conductor assembly with the appropriate bar and insulating cover for your application.

For information on other conductor assemblies, see page 12.

Basic Figure 8 (FE) Conductor Assemblies

10 ft. Lengths		Assembly Catalog No.		
Conductor Bar No.	Weight Pounds	Indoor Use	Outdoor Use	High Temp. Use
FE-758	4.5	FE-758-2	FE-758-2-SC	FE-758-2XHHT
FE-908	6.5	FE-908-2	FE-908-2-SC	FE-908-2XHHT
FE-1608	6.5	FE-1608-2	FE-1608-2-SC	FE-1608-2XHHT
FE-2008	6.25	FE-2008-2	FE-2008-2-SC	FE-2008-2XHHT
FE-3008	6.75	FE-3008-2	FE-3008-2-SC	FE-3008-2XHHT
FE-5008	11.5	FE-5008-2	FE-5008-2-SC	FE-5008-2XHHT



Cross-sectional drawing of Basic Figure 8 (FE) Conductor Assembly

Typical Conductor Mounting

Note: ← S → indicates minimum conductor spacing.

Standard Vertical Mounted Conductors

3-Phase System • Bottom Contact • 5 Ft. Maximum Support Spacing

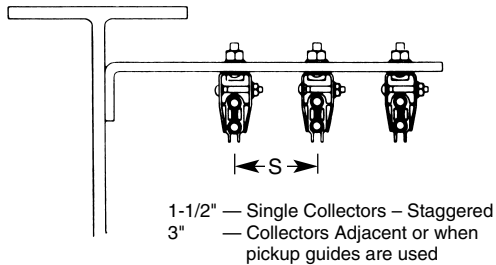

Monorail Application

Install two conductors on one side of the beam and one conductor on the opposite side to balance the collector spring forces, particularly on light weight hoists.

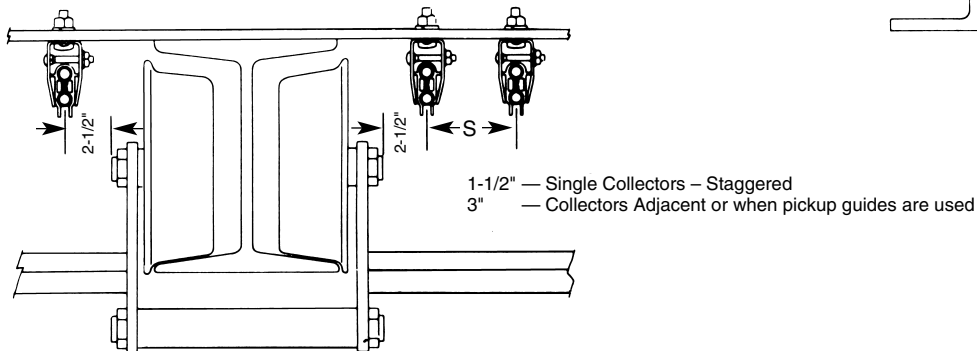

Lateral Mounted Conductors



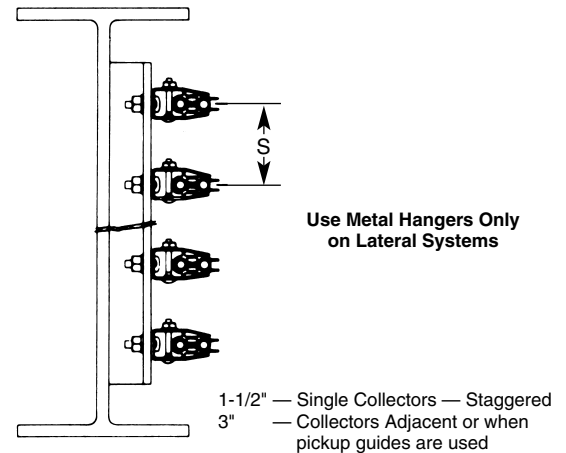



4 Ft. Maximum Support Spacing.
Use only Lateral (L) Model Collectors.

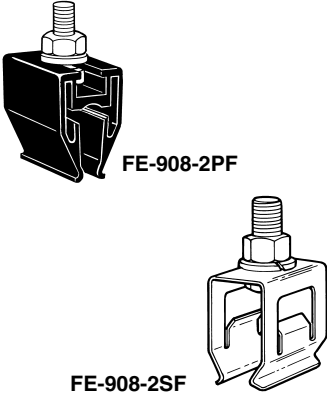

Duct-O-Bar Figure 8 (FE) Components

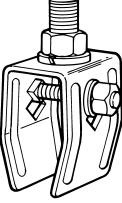

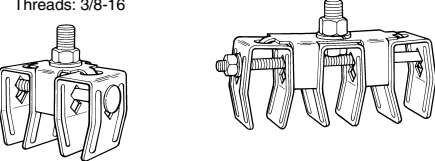
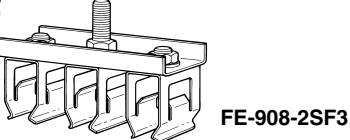
	Catalog Number	Weight Pounds	Description
	B-100-BR1A	1.0	Angle Brackets for Web Mounting <i>Brackets are galvanized 12 gage rolled steel channel. Hangers are priced separately, but will be factory installed at no charge when hanger locations are shown on sketch.</i> Bracket — 11-1/4" long.
	B-100-BR7A	1.12	Bracket — 15-3/4" long.
	B-100-BR7B	1.18	Bracket with gusset support — 15-3/4" long.
	B-100-BR13A	1.5	Bracket — 20-1/4" long.
	B-100-BR13B	1.57	Bracket with gusset support — 20-1/4" long.

	Catalog Number	Weight Pounds	Description
<p>Hole Spacing: 1-1/2" Typical Hole Dia.: 7/16"</p> <p>Capped I-Beam</p> <p>"J" Bolts: 3/8-16 x 4"</p>	<p>B-100-BR3A B-100-BR4A</p> <p>B-100-BR5A B-100-BR6A</p> <p>B-100-BR9A B-100-BR10A</p> <p>B-100-BR B-100-TMC-U</p> <p>B-100-BR4A-J</p> <p>B-100-BR6A-J</p> <p>B-100-BR10A-J</p>	<p>1.25 1.82</p> <p>1.32 2.01</p> <p>1.60 2.19</p> <p>8.0 .31</p> <p>1.75</p> <p>1.94</p> <p>2.12</p>	<p>Straight Brackets for Top Flange Mounting</p> <p><i>Brackets are galvanized 12 gage rolled steel channel. Hangers are priced separately, but will be factory installed at no charge when hanger locations are shown on sketch.</i></p> <p>Bracket — 18" long.</p> <p>Bracket with two Mounting Clamps and hardware — 18" long.</p> <p>Bracket — 21" long.</p> <p>Bracket with two Mounting Clamps and hardware — 21" long.</p> <p>Bracket — 24" long.</p> <p>Bracket with two Mounting Clamps and hardware — 24" long.</p> <p>Channel — 10 feet long.</p> <p>Universal Mounting Clamps with hardware. For 5/8" to 1-5/16" thick Beam Flanges.</p> <p>Capped I-Beam Bracket with hardware. 18" long.</p> <p>Capped I-Beam Bracket with hardware. 21" long.</p> <p>Capped I-Beam Bracket with hardware. 24" long.</p>
<p>Hole Spacing: 1-1/2" Typical Hole Dia.: 7/16"</p> <p>Mounting Plate Hole Spacing: 3-3/8" Mounting Bolts: 1/2-13 x 2"</p>	<p>B-100-BRCT1 B-100-BRCT2 B-100-BRCT3 B-100-BRCT4 B-100-BRCT5 B-100-BRCT6 B-100-BRCT7 B-100-BRCT8 B-100-BRCT9 B-100-BRCT10 B-100-BRCT11</p>	<p>1.2 1.3 1.5 1.6 1.7 1.8 1.9 2.0 2.1 2.2 2.3</p>	<p>Straight Brackets w/ Mounting Plate for Web Mounting</p> <p><i>Brackets are primed 12 gage rolled steel channel with mounting plate and hardware. Hangers are priced separately, but will be factory installed at no charge when hanger locations are shown on sketch.</i></p> <p>Bracket — 2 holes — 3-3/4" long.</p> <p>Bracket — 3 holes — 5-1/4" long.</p> <p>Bracket — 4 holes — 6-3/4" long.</p> <p>Bracket — 5 holes — 8-1/4" long.</p> <p>Bracket — 6 holes — 9-3/4" long.</p> <p>Bracket — 7 holes — 11-1/4" long.</p> <p>Bracket — 8 holes — 12-3/4" long.</p> <p>Bracket — 9 holes — 14-1/4" long.</p> <p>Bracket — 10 holes — 15-3/4" long.</p> <p>Bracket — 11 holes — 17-1/4" long.</p> <p>Bracket — 12 holes — 18-3/4" long.</p>
<p>Typical Hole Dia.: 7/16" Bolts: 3/8-16 x 1-1/2"</p> <p>Hanger Holes</p> <p>Mounting Holes</p> <p>3"</p>	<p>B-100-BRZ1 B-100-BRZ2</p> <p>B-100-BRZ3</p> <p>B-100-BRZ4 B-100-BRZ5</p>	<p>1.0 1.2</p> <p>1.64</p> <p>1.8 2.3</p>	<p>Z-Brackets for Lateral Mounted Conductors</p> <p><i>Brackets are red primed 10 gage steel. Hangers are priced separately, but will be factory installed at no charge when hanger locations are shown on sketch.</i></p> <p>Z-Bracket — 1-1/2" hanger spacing, 3" mounting hole spacing. O.A.L. — 4-1/2"</p> <p>Z-Bracket with hardware — 1-1/2" hanger spacing, 3" mounting hole spacing. O.A.L. — 4-1/2"</p> <p>Z-Bracket — 3" hanger spacing, 6" mounting hole spacing. O.A.L. — 7-1/2".</p> <p>Z-Bracket with hardware — 3" hanger spacing, 6" mounting hole spacing. O.A.L. — 7-1/2".</p> <p>Z-Bracket — 3" hanger spacing, 9" mounting hole spacing. O.A.L. — 10-1/2".</p>

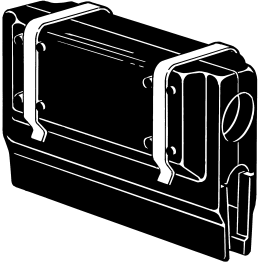
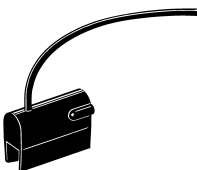
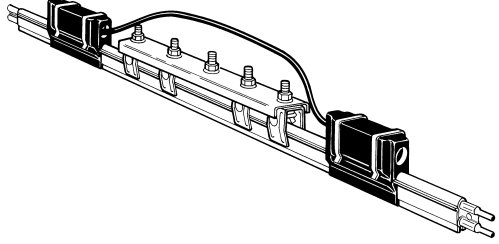
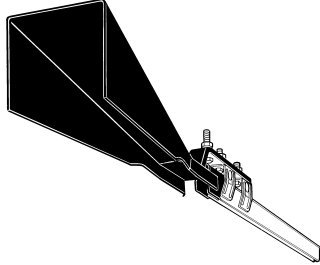
	Catalog Number	Weight Pounds	Description
<p>Threads: 3/8-16</p>  <p>FE-908-2PF</p> <p>FE-908-2SF</p>	<p>FE-908-2PF FE-908-2PFS</p> <p>FE-908-2SF FE-908-2SFE FE-908-2SFS</p>	<p>.10 .10 .11 .11 .11</p>	<p>Snap-In Type Hanger Assemblies <i>These hangers are not recommended for curves, switches or short runs unless separate anchors are used. Refer to the Figure 8 Installation Instructions.</i></p> <p>Nylon Insulating Hanger. Nylon Insulating Hanger with Stainless Steel Hardware. <i>DO NOT USE nylon hangers in temperatures higher than 230°F. DO NOT exceed 4 lb. per foot torque when tightening nut on mounting bolt.</i> Zinc Plated Steel Hanger. Epoxy Coated Steel Hanger. Stainless Steel Hanger with Stainless Steel Hardware.</p>
<p>Threads: 3/8-16</p> 	<p>FE-908-2SFG FE-908-2SFFG FE-908-2SFSG</p>	<p>.20 .20 .20</p>	<p>Snap-In Type Spring Hanger and Insulator Assemblies for Outdoor, Wet and Dirty Applications Zinc Plated Steel Hanger with Insulator. Epoxy Coated Steel Hanger with Insulator. Stainless Steel Hanger with Insulator and Stainless Steel Hardware.</p>
<p>Threads: 3/8-16</p> 	<p>B-100-2FF B-100-2FFE B-100-2FFS</p>	<p>.19 .19 .19</p>	<p>Clamp Type Hanger Assemblies for All Conductor Systems Zinc Plated Steel Hanger. Epoxy Coated Steel Hanger. For special environments. Stainless Steel Hanger with Stainless Steel Hardware. For special environments.</p>
<p>Threads: 3/8-16</p> 	<p>B-100-2FG B-100-2FFG B-100-2FSG</p>	<p>.30 .30 .30</p>	<p>Clamp Type Hanger and Insulator Assemblies for Outdoor, Wet and Dirty Applications. Zinc Plated Steel Hanger with Insulator. Epoxy Coated Steel Hanger with Insulator. Stainless Steel Hanger with Stainless Steel Hardware.</p>
<p>Threads: 3/8-16</p> 	<p>B-100-2F2 B-100-2F3</p>	<p>.40 .59</p>	<p>Clamp Type Special Hanger Assemblies Zinc Plated Steel Twin Hanger Assembly. 1-1/2" centers. For indoor applications. Staggered Collectors. Zinc Plated Steel Triple Hanger Assembly. 1-1/2" centers. For indoor dry applications only. Staggered Collectors.</p>
<p>Threads: 3/8-16 Centers: 1-1/2"</p>  <p>FE-908-2SF3</p>	<p>FE-908-2PF3 FE-908-2SF3 FE-908-2SF4 FE-908-2SF5</p>	<p>.50 .53 .72 .93</p>	<p>Snap-In Type Special Hanger Assemblies Plastic Triple Hanger Assembly. Zinc Plated Steel Triple Hanger Assembly. Zinc Plated Steel Four-Gang Hanger Assembly. Zinc Plated Steel Five-Gang Hanger Assembly.</p>
<p>Threads: 3/8-16</p> 	<p>B-100-1G</p>	<p>.12</p>	<p>Mushroom Insulators with Hardware 30% Glass-filled Nylon — 400°F rated. Suitable for chemical or oil-laden atmospheres.</p>

	Catalog Number	Weight Pounds	Description
	FE-908-2CP	.25	Power Feeds with Insulating Case 90 Amp Rated — Steel. For FE-758-2 systems. Will accept up to # 4 AWG cable. 110 Amp Rated — Copper. For FE-908-2 systems. Will accept up to # 2 AWG cable. 250 Amp Rated — Bronze. For FE-1608-2 and FE-2008-2 systems. Will accept up to # 1/0 AWG cable. 350 Amp Rated — Cast Bronze. For FE-3008-2 systems. Will accept up to # 3/0 cable.
	FE-1158-2CP	.26	
	FE-2008-2CP	.63	
	FE-3008-2CP	1.10	
	FE-758-GCTP	.14	End Power Feeds 40 Amp Rated. For all systems with FE-758 conductor bar. 40 Amp Rated. For all systems with FE-908, FE-1608, FE-2008, and FE-3008 conductor bar.
	FE-908-GCTP	.14	
 <p>Anchor sets and connector pins are included with the hardware package.</p>	FE-758-2H10 FE-758-2H10-SC FE-758-2H10XT FE-908-2H10 FE-908-2H10-SC FE-908-2H10XT FE-1608-2H10 FE-1608-2H10-SC FE-1608-2H10XT FE-2008-2H10 FE-2008-2H10-SC FE-2008-2H10XT FE-3008-2H10 FE-3008-2H10-SC FE-3008-2H10XT FE-5008-2H10 FE-5008-2H10-SC FE-5008-2H10XT	7.0 7.0 7.0 9.0 9.0 9.0 10.5 10.5 10.5 10.5 10.0 10.0 10.0 10.0 12.5 12.5 12.5 12.5 16.5 16.5 16.5	Expansion Gap Assemblies <i>Each assembly consists of a ten-foot conductor bar, insulating cover, connector pins for one end, guide assembly, two power feeds with a jumper cable and hanger set. Refer to the Figure 8 Installation Instructions.</i> For Indoor System FE-758-2. For Outdoor System FE-758-2-SC. For High Temperature System FE-758-2XHT. For Indoor System FE-908-2. For Outdoor System FE-908-2-SC. For High Temperature System FE-908-2XHT. For Indoor System FE-1608-2. For Outdoor System FE-1608-2-SC. For High Temperature System FE-1608-2XHT. For Indoor System FE-2008-2. For Outdoor System FE-2008-2-SC. For High Temperature System FE-2008-2XHT. For Indoor System FE-3008-2. For Outdoor System FE-3008-2-SC. For High Temperature System FE-3008-2XHT. For Indoor System FE-5008-2. For Outdoor System FE-5008-2-SC. For High Temperature System FE-5008-2XHT.
	FE-2JNN3 FE-2JNN4	3.75 4.50	Special Application Components Pickup Guide Assembly — 3" wide. Includes clamps and two foot section of system conductor. Specify conductor system. Pickup Guide Assembly — 4" wide. Includes clamps and two foot section of system conductor. Specify conductor system.

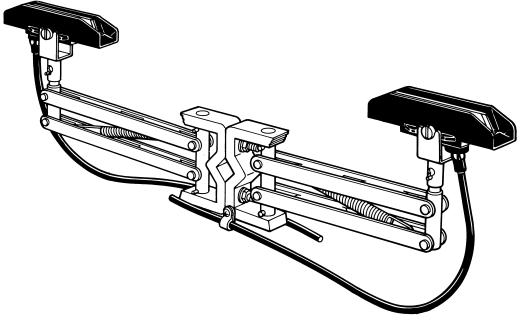
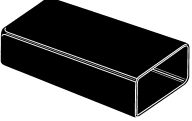
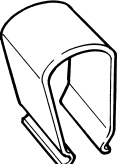
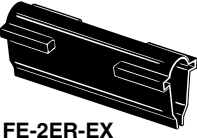
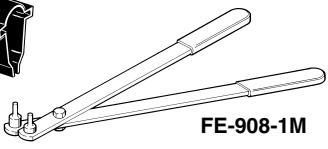
	Catalog Number	Weight Pounds	Description
<p>FE-758-GCT</p> <p>FE-908-IP</p> <p>FE-908-IS</p> <p>B-100-TG</p>	<p>FE-758-GCT</p> <p>FE-758-GCTL</p> <p>FE-758-GCTR</p> <p>FE-908-GCT</p> <p>FE-908-GCTL</p> <p>FE-908-GCTR</p> <p>FE-908-IP</p> <p>FE-908-IS</p> <p>B-100-TG</p> <p>B-100-TGE</p>	<p>.08</p> <p>.08</p> <p>.08</p> <p>.08</p> <p>.08</p> <p>.08</p> <p>.08</p> <p>.02</p> <p>.19</p> <p>1.81</p> <p>1.81</p>	<p>Special Application Components (cont.)</p> <p>Transfer Cap. For FE-758 Bar only.</p> <p>Transfer Cap. For FE-758 Bar only. Cut at 45° for left hand curves.</p> <p>Transfer Cap. For FE-758 Bar only. Cut at 45° for right hand curves.</p> <p>Transfer Cap. For FE-908, FE-1608, FE-2008, and FE-3008 Bar.</p> <p>Transfer Cap. For FE-908, FE-1608, FE-2008, and FE-3008 Bar. Cut at 45° for left hand curves.</p> <p>Transfer Cap. For FE-908, FE-1608, FE-2008, and FE-3008 Bar. Cut at 45° for right hand curves.</p> <p>Isolating Piece — 1" long. For all bars except FE-758 and FE-5008.</p> <p>Isolating Piece — 8" long. For all bars except FE-758 and FE-5008.</p> <p>Steel Transfer Guide Assembly. For use with isolating pieces.</p> <p>Epoxy Coated Transfer Guide Assembly. For use with isolating pieces.</p>
<p>Maximum O.A.L.: 12-1/4"</p> <p>C-100-V5</p>	<p>C-40-V3</p> <p>C-40-L3</p> <p>C-100-V5</p> <p>C-100-L5</p>	<p>1.5</p> <p>2.75</p> <p>1.80</p> <p>3.13</p>	<p>C-Series Collector Assemblies</p> <p><i>C-Series Collectors are used on short continuous run systems. They feature steel pivot points for good tracking capability.</i></p> <p>40 Amp Collector — single shoe. Vertical mount.</p> <p>40 Amp Collector — single shoe. Lateral mount with steel counter weight. O.A.L. — 15"</p> <p>100 Amp Collector — single shoe. Vertical mount.</p> <p>100 Amp Collector — single shoe. Lateral mount with steel counter weights. O.A.L. — 16"</p>
<p>Bolts: 3/8 - 16 x 1-1/2"</p>	<p>FC-TB1</p>	<p>3.25</p>	<p>Collector Mounting Post</p> <p>Mounting Post with Hardware — 18" long. Mounting plate is 4" square with 3" hole spacing for C-Series and P-Series Collectors. (Contact factory for special lengths or finishes.)</p>
<p>Maximum O.A.L.: 15-1/4"</p> <p>P-100-V5</p>	<p>P-40-V3</p> <p>P-40-L3</p> <p>P-40-S3</p> <p>P-100-V5</p> <p>P-100-L5</p> <p>P-100-S5</p>	<p>2.19</p> <p>2.50</p> <p>2.25</p> <p>2.44</p> <p>2.55</p> <p>2.60</p>	<p>P-Series Collector Assemblies</p> <p><i>P-Series Collectors are used on straight and curved runs and transfers. The pantograph design provides virtually constant spring pressure for the entire stroke range. Lateral Mount Collectors are provided with spring balance. Conductor Bars must be spaced at least 3 inches apart. To order bronze collectors with stainless steel hardware, add "BR" to the catalog number. Call factory for prices.</i></p> <p>40 Amp Collector — single shoe. Vertical mount.</p> <p>40 Amp Collector — single shoe. Lateral mount.</p> <p>40 Amp Collector — single shoe. Self-centering.</p> <p>100 Amp Collector — single shoe. Vertical mount.</p> <p>100 Amp Collector — single shoe. Lateral mount.</p> <p>100 Amp Collector — single shoe. Self-centering.</p>

	Catalog Number	Weight Pounds	Description
<p>Maximum O.A.L.: 28"</p>  <p>P-200-VT5</p>	<p>P-80-VT3</p> <p>P-80-LT3</p> <p>P-80-ST3</p> <p>P-200-VT5</p> <p>P-200-LT5</p> <p>P-200-ST5</p>	<p>4.34</p> <p>4.35</p> <p>4.5</p> <p>5.0</p> <p>4.63</p> <p>4.6</p>	<p>P-Series Collector Assemblies (cont.)</p> <p>80 Amp Collector — double shoe. Vertical mount.</p> <p>80 Amp Collector — double shoe. Lateral mount.</p> <p>80 Amp Collector — double shoe. Self-centering.</p> <p>200 Amp Collector — double shoe. Vertical mount.</p> <p>200 Amp Collector — double shoe. Lateral mount.</p> <p>200 Amp Collector — double shoe. Self-centering.</p>
 <p>FE-1GC</p>  <p>B-100-2L</p>  <p>FE-2ER-EX</p>  <p>FE-908-1M</p>  <p>B-100-2FEA</p>	<p>B-100-2L</p> <p>B-100-2FEA</p> <p>FE-1GC</p> <p>FE-908-A</p> <p>FE-908-1M</p> <p>FE-908-1MB</p> <p>FE-2ER-EX</p>	<p>.03</p> <p>.30</p> <p>.04</p> <p>.02</p> <p>2.88</p> <p>.10</p> <p>.05</p>	<p>Additional Components</p> <p>Spring Cover Clip — Zinc Plated Steel. Used only to ensure alignment of the cover on laterally mounted systems. Placed midway between hangers.</p> <p>Clamp Hanger Set — 2 pieces. Clamps both sides of hanger.</p> <p>Flexible PVC End Cap. For all Figure 8 conductor bars.</p> <p>Nylon Anchor Pin. For drilled anchoring. Two required at each hanger.</p> <p>Connector Tool. One tool usually ordered for each new system. Used to pull two sections of bar together.</p> <p>Connector Tool Pins — Pair.</p> <p>Splice Cover — Standard black. Use this part number when ordering extra splice covers.</p>
	<p>C-100-VCT</p> <p>P-100-VCT</p> <p>C-100-2ACT</p> <p>P-100-2ACT</p> <p>B-40-2B3-CI</p> <p>B-100-2B5-CI</p> <p>C-100-CT</p> <p>B-100-TT</p>	<p>1.80</p> <p>2.19</p> <p>.50</p> <p>.57</p> <p>.17</p> <p>.26</p> <p>.14</p> <p>.08</p>	<p>Conductor Bar Cleaning Accessories</p> <p><i>Contact the factory for application.</i></p> <p>Complete C-Series Collector with cleaning head. Vertical mount.</p> <p>Complete P-Series Collector with cleaning head. Vertical mount.</p> <p>Cleaning Head only for C-Series or B-Series Collectors.</p> <p>Cleaning Head only for P-Series Collector.</p> <p>Cast Iron Cleaning Shoe — 3" long x 1/4" wide.</p> <p>Cast Iron Cleaning Shoe — 5" long x 1/4" wide.</p> <p>Cleaning Brush — Stainless Steel.</p> <p>Micro Hone — 1/4" x 4".</p>

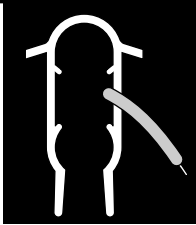

Heated
(HFE)

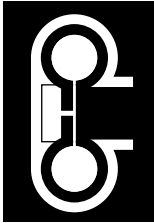

Side Contact
(SFE)

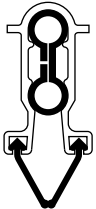

Totally Enclosed
(EFE)

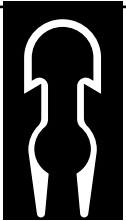

8-Bar
(8-BAR)

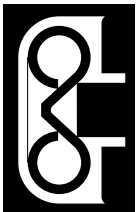

V-Bar
(VFE)